

KENWOOD

STEREO CASSETTE TAPE DECK

1050CT
103CT

INSTRUCTION MANUAL

KENWOOD CORPORATION

This manual contains instructions for two models.
Model availability and features (functions) may differ
depending on the country and sales area.

Introduction

Your choice of this product indicates that you are a devotee to excellence in sound reproduction.

We appreciate your patronage and take pride in the long tradition of quality components that our company represents.

So that you can get the most out of your unit, we suggest that you take the time to read through this manual before you hook up and operate your system. This will acquaint you with operating features and system-connection considerations so that your listening pleasure will be enhanced right from the start. You will notice that in all aspects of planning, engineering, styling, operating convenience and adaptability we have sought to anticipate your needs and desires.

Keep this manual handy for future reference.

For your records

Record the serial number, found on the back of the unit, in the spaces designated on the warranty card, and in the space provided below. Refer to the model and serial numbers whenever you call upon your dealer for information or service on this product.

Model _____ Serial Number _____

Unpacking

Unpack the unit carefully and make sure that all accessories are put aside so they will not be lost. Examine the unit for any possibility of shipping damage. If your unit is damaged or fails to operate, notify your dealer immediately. If your unit was shipped to you directly, notify the shipping company without delay. Only the consignee (the person or company receiving the unit) can file a claim against the carrier for shipping damage.

We recommend that you retain the original carton and packing materials for use should you transport or ship the unit in the future.

Accessories

Audio cord 2

System control cord 1

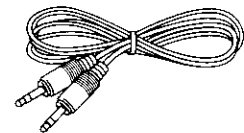
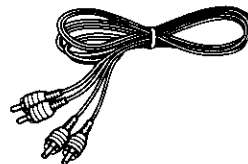

Contents

Caution : Read the pages marked  carefully to ensure safe operation.

Special features	3	How to record	14
! Before applying power	3	Ordinary recording	14
! Safety precautions	3	To make better recordings	15
Before Operation	4	To pause recording temporarily	16
Maintenance	5	To stop recording	16
System connections	6	How to provide non-recorded blanks between programs	16
Controls and indicators	8	To re-start recording	16
Listening to cassette tapes	10	Relay recording (1050CT only)	17
To playback a tape	10	Synchro recording	18
Fast forward and rewind	11	Synchro recording of CD	18
Relay playback	11	Synchro recording of analog disc	19
DPSS operation	12	Recording of CD playback (CCRS) (Deck B only)	20
Skip play operation	12	Tape dubbing operation (Deck A → Deck B)	21
Rewind & Play operation	13	Timer operations	22
Single-tune repeated playback operation	13	Timer playback of tape	22
Dash & Play operation	13	Timer recording of tuner broadcast	23
Zero-stop operation	13	In case of difficulty	24
		Specifications	26

Special features

- Dolby HX Pro and Auto-Bias function:** The Dolby HX Pro headroom extension and auto-bias function provide a recording with superior high-frequency characteristics.
- DPSS functions:** Simple operations allow you to use the following convenient functions.
 1 Skip Play 2 Single-tune repeated playback 3 Rewind & Play 4 Dash & Play
 (DPSS: Direct Program Search System)
- CCRS function:** This function automatically sets the optimum recording level of the disc to be recorded, making it easy to record a CD.
 (CCRS: Computer-Controlled CD Recording System)
- Dubbing function:** With an easy operation, the tape loaded in deck A can be dubbed onto the tape in deck B.

Before applying power

 **Caution: Read this section carefully to ensure safe operation.**

Units are designed for operation as follows.

- U.S.A. and Canada AC 120 V only
 * Other countries AC 110-120 / 220-240 V switchable

*AC voltage selection

The AC voltage selector switch on the rear panel is set to the voltage that prevails in the area to which the unit is shipped. Before connecting the power cord to your AC outlet, make sure that the setting position of this switch matches your line voltage. If not, it must be set to your voltage in accordance with the following direction.

AC voltage selector switch

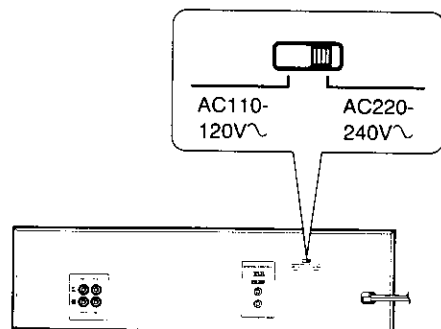





Move switch lever to match your line voltage with a small screwdriver or other pointed tool.

Note:
 Our warranty does not cover damage caused by excessive line voltage due to improper setting of the AC voltage selector switch.

Safety precautions

 **Caution: Read this section carefully to ensure safe operation.**

WARNING: TO PREVENT FIRE OR ELECTRIC SHOCK, DO NOT EXPOSE THIS APPLIANCE TO RAIN OR MOISTURE.

 <div style="border: 1px solid black; padding: 2px; text-align: center;"> CAUTION RISK OF ELECTRIC SHOCK DO NOT OPEN </div> 	<p>CAUTION: TO REDUCE THE RISK OF ELECTRIC SHOCK, DO NOT REMOVE COVER (OR BACK). NO USER-SERVICEABLE PARTS INSIDE. REFER SERVICING TO QUALIFIED SERVICE PERSONNEL.</p>
	<p>THE LIGHTNING FLASH WITH ARROWHEAD SYMBOL, WITHIN AN EQUILATERAL TRIANGLE, IS INTENDED TO ALERT THE USER TO THE PRESENCE OF UNINSULATED "DANGEROUS VOLTAGE" WITHIN THE PRODUCT'S ENCLOSURE THAT MAY BE OF SUFFICIENT MAGNITUDE TO CONSTITUTE A RISK OF ELECTRIC SHOCK TO PERSONS.</p>
	<p>THE EXCLAMATION POINT WITHIN AN EQUILATERAL TRIANGLE IS INTENDED TO ALERT THE USER TO THE PRESENCE OF IMPORTANT OPERATING AND MAINTENANCE (SERVICING) INSTRUCTIONS IN THE LITERATURE ACCOMPANYING THE APPLIANCE.</p>

Before Operation

Notes on cassette tape

Safety tab (accidental erasure prevention tab)

After an important recording has been finished, break the safety tab, to prevent the recorded contents from being erased or recorded on accidentally.

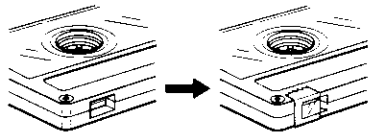
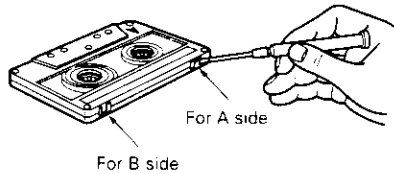

To re-record

Apply tape only to the position where the tab has been removed.

To store cassette tapes

Do not store the tapes in a place which is subject to direct sunlight, or near equipment that generates heat. Keep the cassette tapes away from any magnetic field.

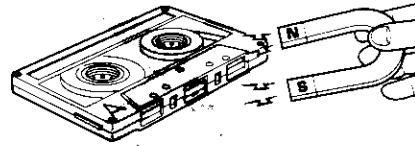

When there is slack in the tape

In such a case, insert a pencil into the reel hole and wind the reel hub to remove the slack.

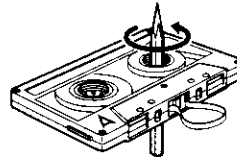

1. Longer tape than 110 minutes cassette tape

Since longer tape than 110 minutes cassette tape is very thin, the tape could adhere to the pinch roller or be easily cut. It is recommended that these tapes not be used with this unit to prevent possible damage.



2. Endless tapes

Do not use an endless tape, as this could damage the mechanism of the unit.

Beware of condensation

When water vapor comes into contact with the surface of cold material, water drops are produced.

If condensation occurs, correct operation may not be possible, or the unit may not function correctly.

This is not a malfunction, however, and the unit should be dried. (To do this, turn the POWER switch ON and leave the unit as it is for several hours.)

Be especially careful in the following conditions:

- When the unit is brought from a cold place to a warm place, and there is a large temperature difference.
- When a heater starts operating.
- When the unit is brought from an air-conditioned place to a place of high temperature with high humidity.
- When there is a large difference between the internal temperature of the unit and the ambient temperature, or in conditions where condensation occurs easily.

Temperature

The appliance may not function properly if used at extremely low, or freezing temperatures. The ideal ambient temperature is above +5°C (41°F).

WARNING NOTICE:

IN MOST CASES IT IS AN INFRINGEMENT OF COPYRIGHT TO MAKE COPIES OF TAPES OR DISCS WITHOUT THE PERMISSION OF THE COPYRIGHT OWNERS. ANYONE WISHING TO COPY COMMERCIALY AVAILABLE TAPES OR DISCS SHOULD CONTACT THE MECHANICAL COPYRIGHT PROTECTION SOCIETY LIMITED OR THE PERFORMING RIGHTS SOCIETY LIMITED.

Dolby noise reduction and HX Pro headroom extension manufactured under license from Dolby Laboratories Licensing Corporation. HX Pro originated by Bang & Olufsen "DOLBY", the double-D symbol and "HX PRO" are trademarks of Dolby Laboratories Licensing Corporation.

Maintenance

Cleaning the head section

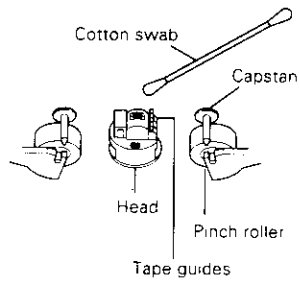

Cleaning the heads and peripheral components

For maintaining the best condition of the deck and for longer service life, always keep the head (recording/playback/erase), capstan and pinch roller clean. To clean them, perform the following:

1. Open the cassette holder.
2. Using a cotton swab dipped in alcohol, clean the head (recording/playback/erase), capstan and pinch roller carefully.

Demagnetizing the head

When the recording/playback head is magnetized, the sound quality will be deteriorated. In such a case, demagnetize the head using a commercially available demagnetizer (head eraser).



There are precisely aligned parts around the heads, including the tape guides. When cleaning, pay special attention so as not to apply shock to them.

Cleaning

Unplug this appliance from the wall outlet before cleaning. Do not use volatile solvents such as alcohol, paint thinner, gasoline, or benzine, etc. to clean the cabinet. Use a clean dry cloth.

Do not use contact cleaners because it could cause a malfunction. Be specially careful against contact cleaners containing oil, for they may deform the plastic components.

System connections

Make connections as shown below. When connecting the related system components, refer also to the instruction manuals of the related components.

Caution: Do not plug in the power lead until all connections are completed.

Malfunction of microcomputer

If operation is not possible or erroneous display appears even though all connections have been made properly, reset the microcomputer referring to "In case of difficulty".

-23-

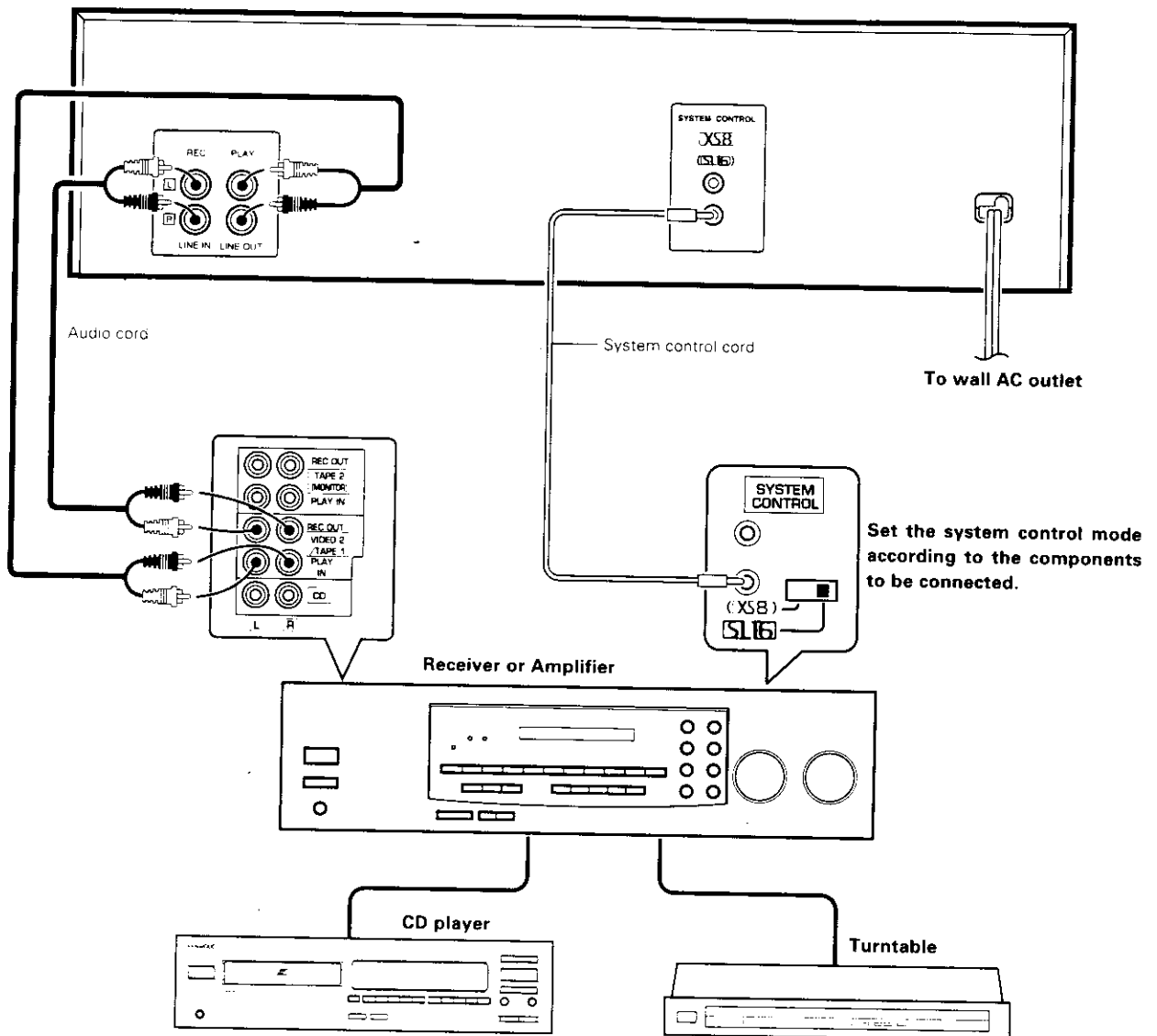

- 1 Connect all cords firmly. If connections are loose, there could be loss of sound or noise produced.
- 2 When plugging and unplugging connection cords, be sure to first remove the power cord from the AC outlet. Plugging/unplugging connection cords without removal of the power cord can cause malfunctions or damage to the unit.

ABOUT THE SYSTEM CONTROL CONNECTIONS

Connecting system control cords after connecting a KENWOOD audio component system lets you take advantage of convenient system control operations.

There are two KENWOOD system control modes. Make connections according to the groups of terminal symbols shown below.

[XS8] Mode : lets you combine [XR], [XS] and [XS8] terminals

[SL16] Mode : for [SL16] terminals only

This unit is compatible with both [XS8] and [SL16] modes. It comes from the factory set to the [XS8] mode. To switch to the [SL16] mode, follow the instructions in "SWITCHING FROM [XS8] TO [SL16]" below.

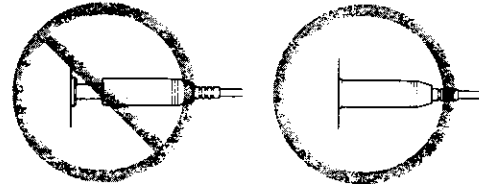

1. [SL16] equipment cannot be combined with [XR], [XS], and [XS8] equipment for system operations. If your equipment consists of this kind of combination, please do not connect any system control cords. Even without system control cords, normal operations can be carried out without affecting performance.
2. If your amplifier or receiver does not have a system control terminal, do not connect any system control cords to the system control terminals on the other components.
3. Do not connect system control cords to any components other than those specified by KENWOOD. It may cause a malfunction and damage your equipment.
4. Be sure the system control plugs are inserted all the way in to the system control terminals.

**ABOUT THE SYSTEM CONTROL OPERATIONS****Remote Control**

Lets you operate this unit with the system remote supplied with the amplifier or receiver.

Automatic Operation (except [XR] equipment)

Automatically switches the input selector on the amplifier or receiver when you start playback from this unit.

Synchronized Recording (except [XR] equipment)

Lets you synchronize recording with the start of playback when recording from CD, MD, LD, or analog discs. Also, the simple CCRS operation lets you make great recordings from CD.

SWITCHING FROM [XS8] TO [SL16]

You can easily change the system control mode with the following operation. Do this operation after completing all connections.

Switching to [SL16]: Hold down the **▶▶ (fast forward)** key on Deck B and switch the **POWER** key from **OFF** to **ON**.

Switching back to [XS8]: Hold down the **◀◀ (rewind)** key on Deck B and switch the **POWER** key from **OFF** to **ON**.

- This operation will not affect items stored in the memory.

Controls and indicators

This illustration shows the 1050CT model.

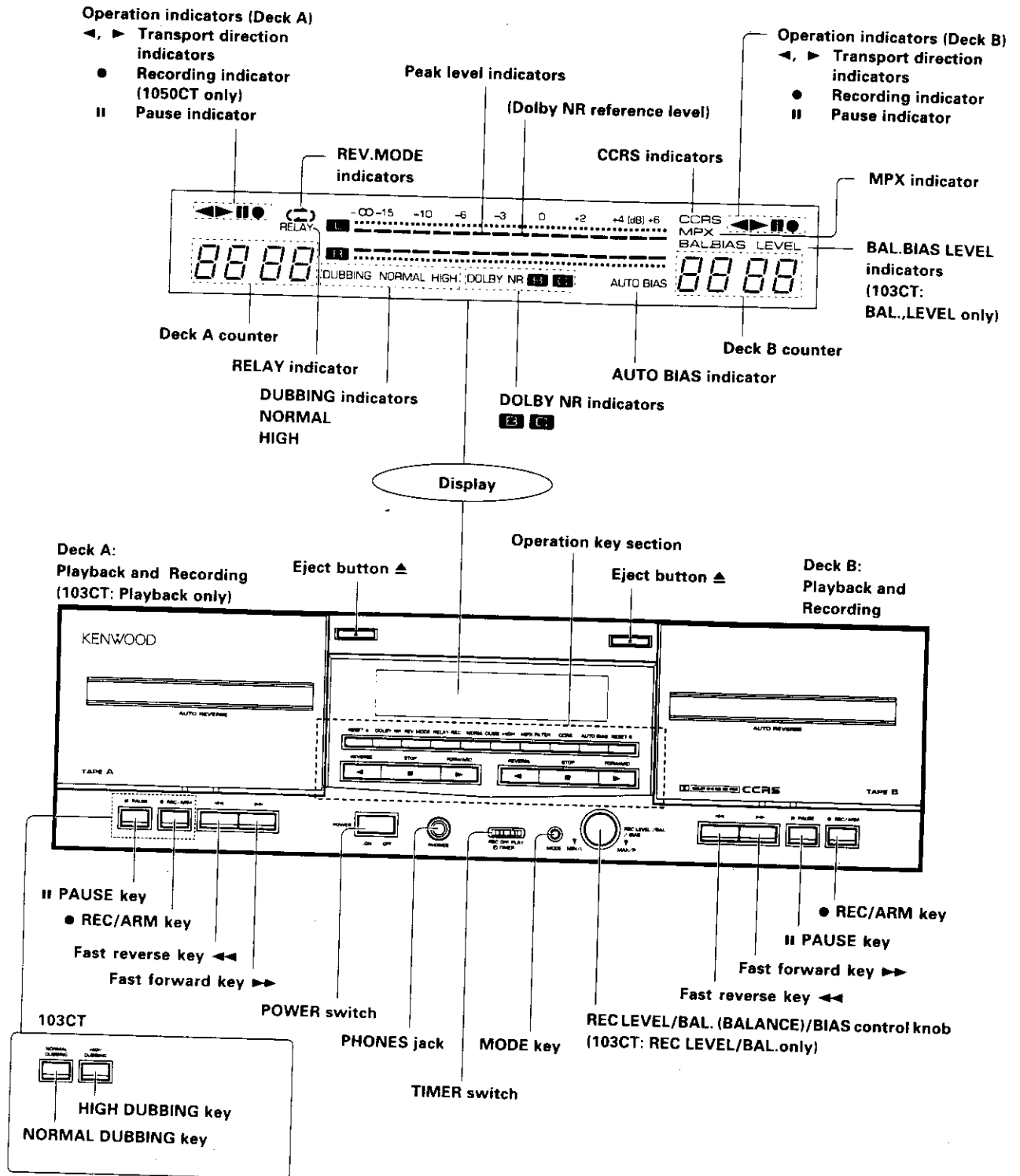

■ Operation key section (1050CT)

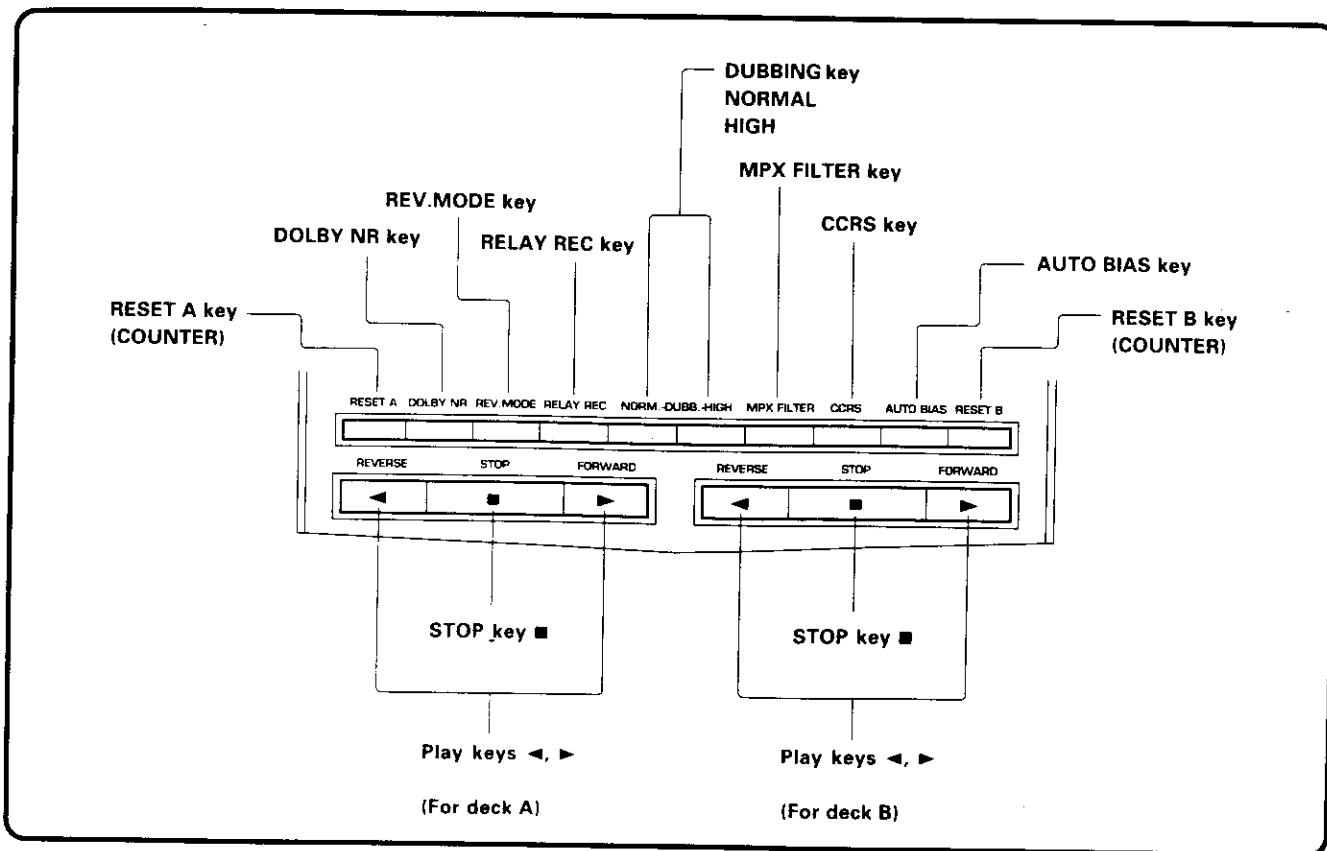

■ Operation key section (103CT)

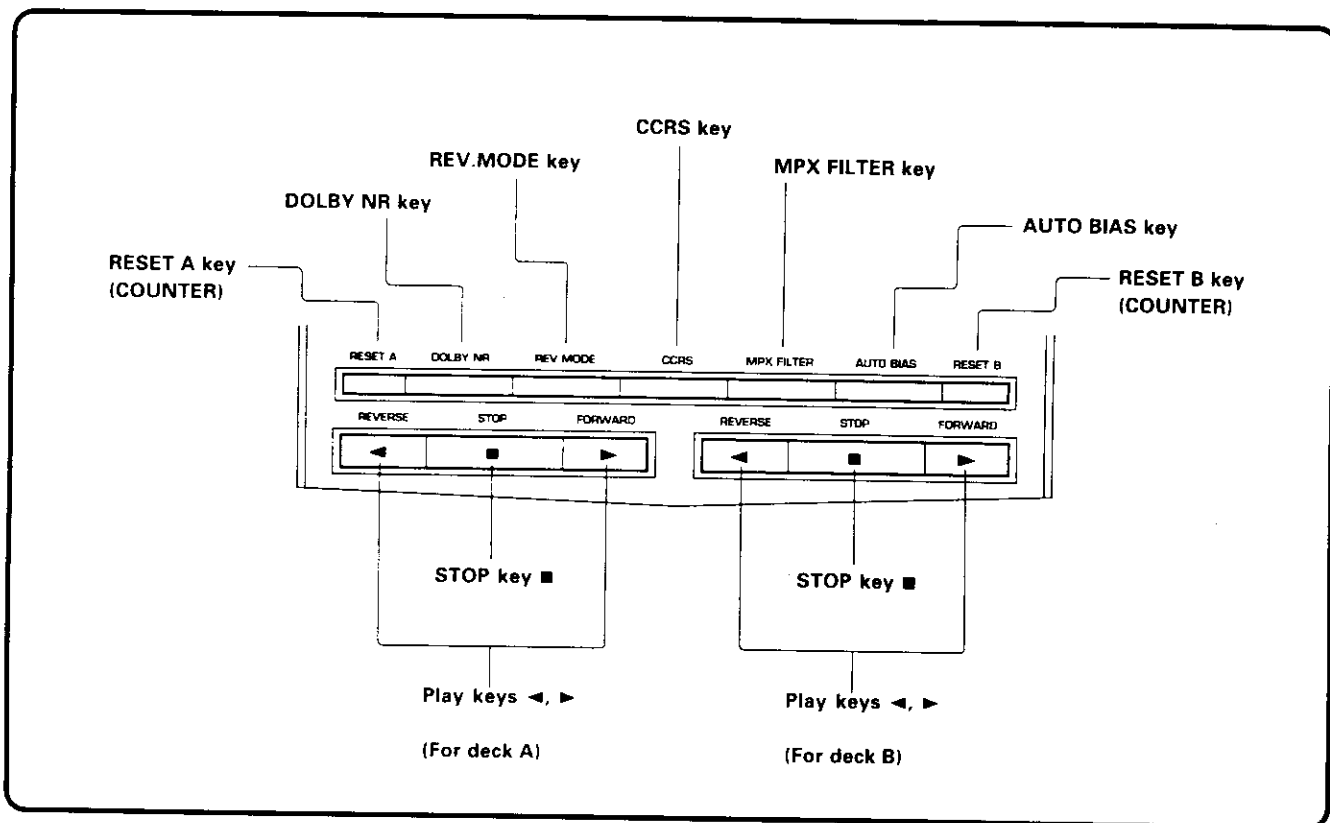

Listening to cassette tapes

Before starting playback

- 1 Set the **TIMER** switch to **OFF**.



- 2 Set the **POWER** switch to **ON**.

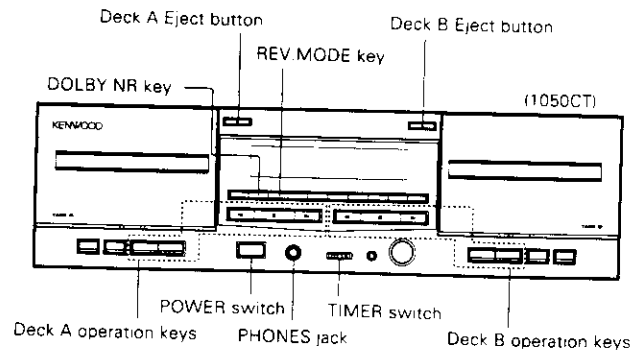

To playback a tape

1 Insert a cassette tape.

- 1 Press the **Eject** button .

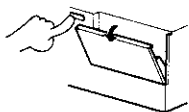

- 2 Insert a tape.

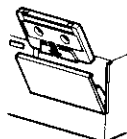

- 3 Close the cassette holder.

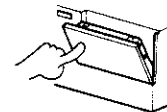

- The type of tape, Normal (TYPE I), High (TYPE II) or Metal (TYPE IV), is detected and set automatically.
- Be sure to remove tape slack before insertion.

Close securely by pressing upper inside.

2 Select direction of travel.

- 1 Press the **◀** key or **▶** key.

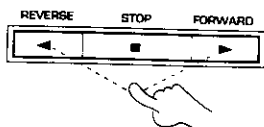

- 2 To stop playback

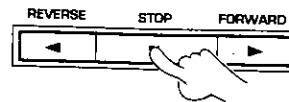

3 Determine the playback conditions.

- 1 Select the **playback mode**.

The display changes every time you press

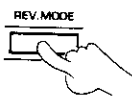

- To stop after playing two sides of tape.
- To play two sides endlessly.
- To stop after playing one side of tape.

- 2 Select the **Dolby NR mode**.

The display changes every time you press.

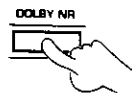

- Select according to the tape to be played.
- DOLBY NR **B**
 - DOLBY NR **C**
- OFF

4 Start playback.

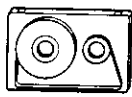

or

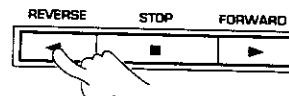
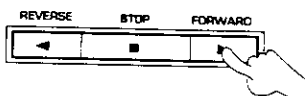
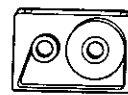

To pause playback

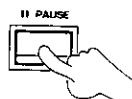

- The pause indicator lights up.

To stop playback

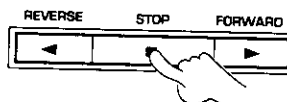

- Do not press the Eject button until the tape has stopped completely.

■ Fast forward and rewind

1 Stop playback.

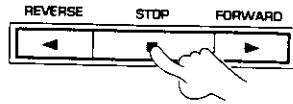

2 Press the ◀◀ key or ▶▶ key.



◀◀ : Fast tape winding in the ← direction ▶▶ : Fast tape winding in the → direction

To stop fast tape winding

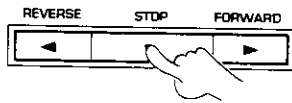

Tape transport direction indicators

The ◀▶ indicators show the direction of tape transport in its playback or recording. The direction selected when the tape was stopped the last time is maintained even after the power is turned off. When the tape is started automatically by the automatic play operation, etc., the transport starts with the direction shown by the direction indicator. If you want to change the transport direction for the next time the power is turned on, press the play key of the opposite direction before turning power off.

Deck A direction indicators Deck B direction indicators

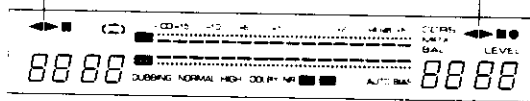

To use the headphone

Connect commercially-available stereo headphones to the **PHONES** jack for private listening

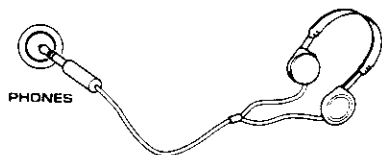

■ Relay playback

This function plays back the tapes in both decks A and B continuously and repeatedly.

1 Insert tapes.

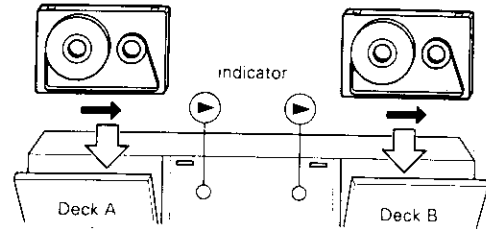

- Tapes are played in the directions indicated by their respective indicators on the display.

2 Select the playback mode.

① Select the playback mode.

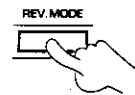

The display changes every time you press.

- ▶▶ Relay playback of two sides of tapes in decks A and B is repeated.
- ◀◀ Relay playback of only one side of tapes in decks A and B is repeated.

- Relay playback cannot be performed if the **REV.MODE** key is set to "◀◀".

② Select the Dolby NR mode.

The display changes every time you press.

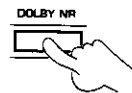

Select according to the tape to be played.

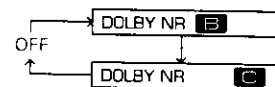

3 Start playback.

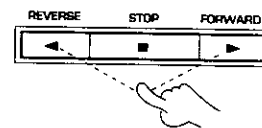

- The playback starts with the deck the play key of which is pressed.

To stop relay playback

Press the ■ key of the deck that is playing.

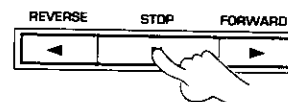

DPSS operation

The DPSS (Direct Program Search System) enables the following convenient operations according to the instructions of the operation keys (these operation are however not available on both decks simultaneously). The DPSS functions are based on the detection of non-recorded spaces of 4 seconds or more between tunes.

1. **Skip play:** By specifying a tune located several tunes beyond (or behind) the tune being played, skips tunes between the current tune and the selected tune and starts playback from the beginning of the selected tune. Up to 16 tunes can be skipped in Skip Search.
2. **Rewind & Play:** Rewinds the tape to the beginning and starts playback from there.
3. **Single-tune repeated playback:** One single tune is played back repeatedly up to 16 times.
4. **Dash & Play:** If a non-recorded space of more than 10 seconds is detected during playback, that space will be skipped by fast forward tape winding.

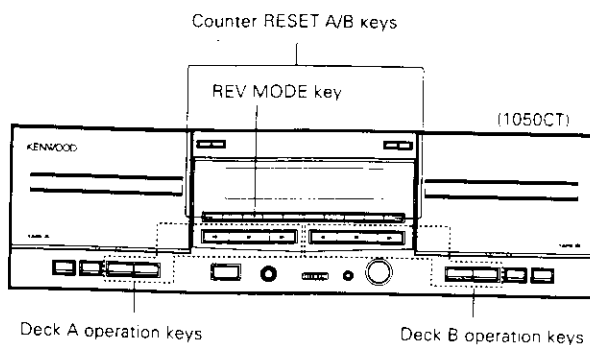
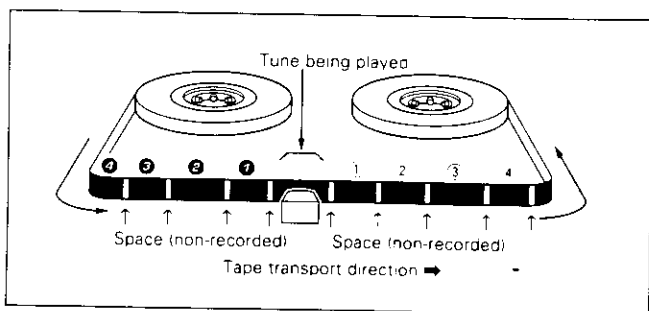

■ Skip play operation

The example below shows the case in which the direction indicated by the tape transport direction indicator is ►. If the direction indicated by the tape direction indicator is ◀, always press the keys for the opposite directions to those shown in the illustrations below.

To play a tune located immediately after the tune being played

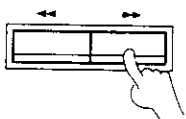

Press once during the playback.

To play the tune being played from the beginning

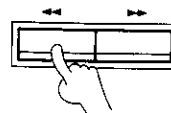

Press once during the playback.

To play a tune located 4 tunes beyond

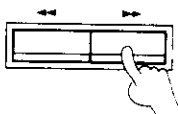

Press 4 times during the playback.

To play the tune located 4 tunes behind

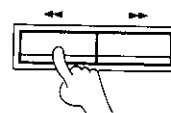

Press 5 times during the playback.

DPSS will not function properly with the following types of tapes.

- Tapes containing spaces of 4 seconds or more, such as conversations and speeches.
- Tape containing extremely low levels or non-recorded spaces in the middle of tunes, such as classical music.
- Tapes containing recording of large noise between tunes.
- Tapes containing spaces of less than 4 seconds between tunes.
- Tapes recorded with low recording level.
- Tapes recorded using Cross-fade recording.

■ Rewind & Play operation

This operation cannot be performed with the remote control (of the separately sold amplifier).

Direction of tape direction indicator: ▶

Press simultaneously.

Direction of tape direction indicator: ◀

Press simultaneous v

■ Single-tune repeated playback operation

1 Play the tune to be repeated.

2 Press the play key of the same direction as the current tape transport direction.

When direction of tape direction indicator is ▶:

- Normal playback resumes after repeating the same tune for 16 times.

■ Dash & Play operation

The Dash & Play skips long non-recorded spaces automatically as the tape is played.

This operation cannot be performed with the remote control (of the separately sold amplifier).

1 Determine the playback mode (conditions).

The display changes every time you press.

- "⏮"..... Two sides are repeated only once, after which playback stops.
- "⏪"..... Two sides are repeated 8 times, after which playback stops.
- "⏩"..... One side is repeated 8 times, after which playback stops.

- In case the **REV.MODE** key is set to "⏩" and tapes are inserted in both of the decks, when a deck finishes Dash & Play, the other deck starts Dash & Play for 16 times, after which it stops.

2 Press the ◀◀ and ▶▶ keys simultaneously.

To cancel the playback above in the middle

- Playback is stopped and canceled

Press once

■ Zero-stop operation

This operation cannot be performed with the remote control (of the separately sold amplifier).

Press simultaneously.

Fast winding in the ◀ direction

Fast winding in the ▶ direction

- Tape is wound until counter reading near "0000" where it stops

Usage of counter

Before starting recording (playback), press the **RESET A** or **RESET B** key to reset the counter to "0000", and write down the counter reading when the recording (playback) should be stopped in the middle of the tape, etc.; this will make it easy to locate the same position when you want to continue recording (playback) next time. It is also possible to use the Zero-stop function to return to the position where recording (playback) was started.



How to record

The cassette deck incorporates the Dolby HX Pro headroom extension function and auto-bias function to provide a recording with superior high-frequency characteristics. Since this unit is not designed for recording with metal (TYPE IV) tapes, do not use metal tapes for recording.

■ Ordinary recording

1 Set up the cassette deck.

① Insert a tape in deck A or B.

(103CT: deck B only)

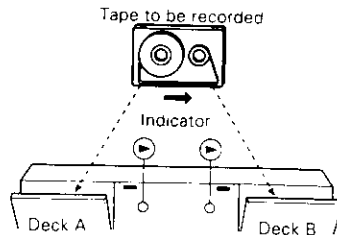

② Set the tape transport direction.

Press the play key, then immediately press the ■ key.

③ Select one-side or two-side recording.

The display changes every time you press.

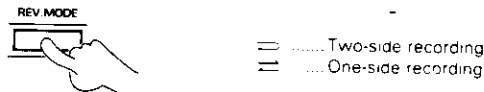

④ Select the Dolby NR mode.

The display changes every time you press.

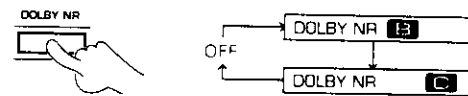

⑤ When recording a radio broadcast

- Depending on the tuner, a recorded FM broadcast may produce a "beat" sound. In this case, press the **MPX FILTER** key before recording. To cancel press the **MPX FILTER** key again.

2 Select the source to be recorded.

3 Activate the auto-bias setting.

The bias adjustment is applied to deck B.

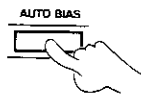

- The optimum bias is set in about 40 seconds, after which the deck enters the stop mode.
- For a fine adjustment after setting AUTO BIAS, refer to the description of "Bias level adjustment" (1050CT only).
- To cancel the auto-bias adjustment operation in the middle, press the ■ key.
- Recording is possible even when the auto-bias setting is omitted.
- If the amount of remaining tape is small, the auto-bias adjustment may be canceled in the middle and tape stopped at that position.
- The bias level is canceled when the Eject button is pressed.

4 Set the recording level.

① Play a music source.

② Enter the record-pause mode.

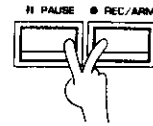

While pressing the II key, press the ● key.

③ Adjust the recording balance and recording level.

- Refer to "To make better recordings".



④ Stop playing the source.

5 Start recording.

① Press the ● key.



Press once.

- Recording will start.

② Play the music source from the beginning.

- The deck enters the stop mode automatically when the tape has been recorded till the end.

Auto-bias function

The tapes categorized as "normal" or "high" tape vary widely in the characteristics from popular to high-class types. Therefore, this system is equipped with the auto-bias adjustment function for exclusive use with normal and high tapes so that optimum recording can always be obtained with any types of normal and high tapes. It is recommended to use the auto-bias function when using a normal tape or high tape.

■ To make better recordings

The **MODE** key can be used to adjust the recording level, the recording balance and the bias level.

Recording level adjustment

① Select the **LEVEL** mode.

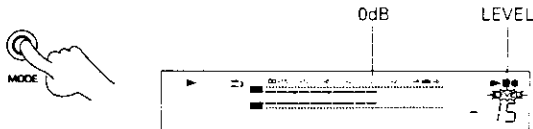

Press the **MODE** key and select the "**LEVEL**".

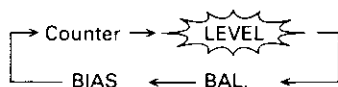

② Adjust the recording level.

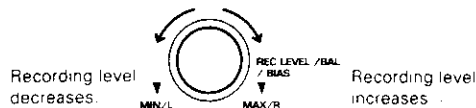

- Adjust the recording level so that the 0 dB of the peak level indicators sometimes lights up.
- The recording level can be adjusted on both decks A and B.

Recording balance adjustment

① Select the **BAL.** mode.

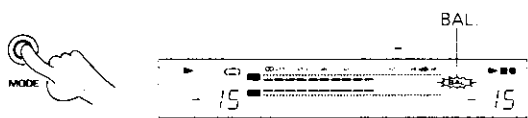

Press the **MODE** key and select the "**BAL**".

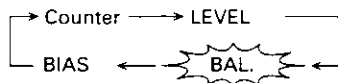

② Adjust the recording balance.

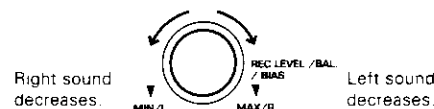

- In counter, adjust the recording balance level so that the left and right displays are the same. You can also check with the **L** and **R** peak level indicators.

Bias level adjustment (Deck B of the 1050CT only)

① Select the **BIAS** mode.



Press the **MODE** key and select the "**BIAS**".

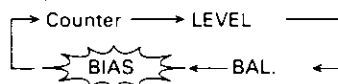

② Adjust the bias level.

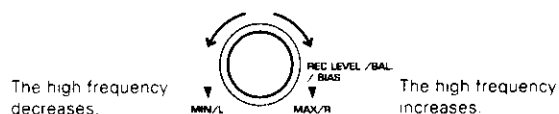

- To adjust the bias level, play back the recorded sound and adjust to the suitable level. Repeat if necessary.
- The bias can be adjusted to a value of ± 3 .

Dolby noise reduction system

The Dolby noise reduction system was developed to reduce the tape hiss noise generated during playback.

The optimum effect of the Dolby NR system is obtained when the same type NR system is used for both recording and playback. If a different type NR system is used, playback is not performed correctly. Make sure that the same type noise reduction system is used for both recording and playback.

Dolby B NR

The most popular noise reduction system used in home audio components. Usually, Dolby NR system corresponds to B NR.

Dolby C NR

Dolby C NR offers improved noise reduction performance over that of the Dolby B NR. It features a superior noise reduction effect, use Dolby C NR to record or playback with this unit.

It is recommended that tapes recorded with the Dolby NR system be marked "B" or "C", so that they can easily be distinguished.

■ To pause recording temporarily

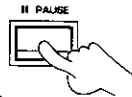

- The pause indicator lights up.

To resume recording

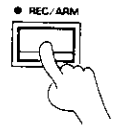

■ To stop recording

1 Press the ■ key.

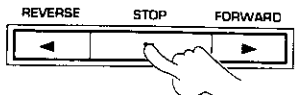

2 Stop playing the source component.

■ How to provide non-recorded blanks between programs

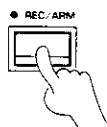
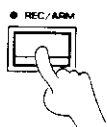
In stop mode	During recording
Press successively twice	Press once
	
<ul style="list-style-type: none"> • After leaving a non-recorded blank of about 4 seconds, the deck enters the record-pause mode 	

■ To re-start recording

The following procedure is useful when you want to cancel recording in progress and re-start it. A non-recorded space of about 4 seconds or more should be reserved before the position where recording was started.

1 Rewind during recording.

During recording in the ► direction:



During recording in the ◀ direction:

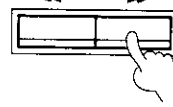

- When the ►► (or ◀◀) key is pressed during recording, recording is aborted and tape is rewound as shown below if there is a non-recorded space of more than 4 seconds before the recording start position.

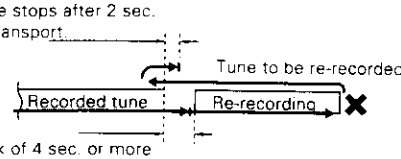

Tape stops after 2 sec. of transport.

Tune to be re-recorded

Recorded tune

Re-recording

Blank of 4 sec. or more

- If there is no recorded tune before, the tape will be rewound then stopped.
- When re-recording from the beginning of tape, feed the leader tape (the first portion of tape that cannot be recorded) before starting re-recording.

2 Re-start recording.

1 Press the ● key twice.

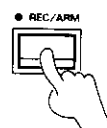

- A non-recorded space of about 4 seconds is reserved on tape, then the tape transport stops.

2 Replay the tune you wish to record.

3 Press the ● key once.

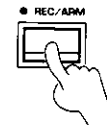

- Recording starts.

Recording with Dolby HX Pro

When recording is started with this unit, the Dolby HX Pro headroom extension function automatically operates to provide a recording with superior high-frequency characteristics

What is Dolby HX Pro?

In ordinary recording using high-frequency biasing, the high-frequency bias current, which should be constant, is increased with some recording sources due to the high-frequency component contained in the music, etc. This increase affects the recording characteristics with distorted high frequencies and degraded dynamic range and frequency response. The Dolby HX Pro circuit detects the high-frequency component contained in the music source being recorded, and reduces excessive bias current to make it constant. As a result, the recording characteristics of high frequencies are drastically improved, and the improved high-frequency reproduction can also be enjoyed even when the tape is played on tape decks which are not equipped with circuit.

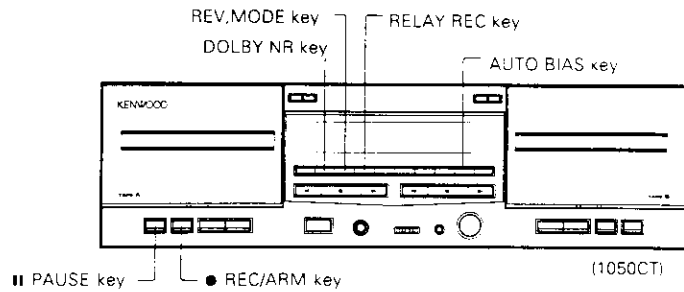

■ Relay recording (1050CT only)

This function allows to record sound continuously from deck A to B.

1 Insert tapes in both decks A and B.

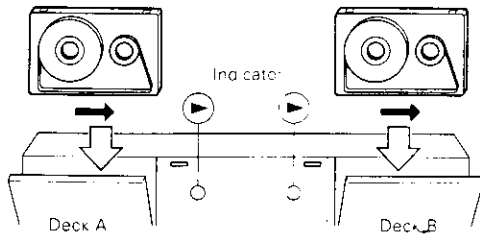

2 Set the recording condition.

1 Select one-side or two-side recording.

The display changes every time you press



2 Select the Dolby NR mode.

The display changes every time you press

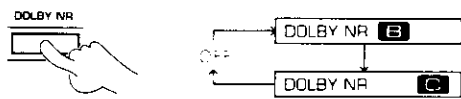

3 Set the relay recording mode.

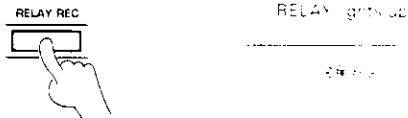

4 Perform auto-bias adjustment.

The bias adjustment is applied to deck B.

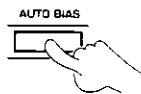

- The optimum bias is set in about 40 seconds, after which the deck enters the stop mode.
- Recording is possible even if the auto-bias adjustment operation is omitted

5 Adjust the recording level.

① Play the music source.

② Set the record-pause mode. (deck A).

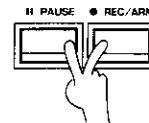

While pressing the || key, press the ● key.

③ Adjust the recording balance and recording level.

- 15

④ Stop playing the music source.

6 Start recording.

① Press the ● key (of deck A).

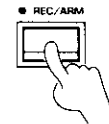

- Recording will start.
- ② Play the music source from the beginning.
- Recording on deck B starts immediately after recording on deck A has completed.

To cancel relay recording

Press the RELAY REC key again.

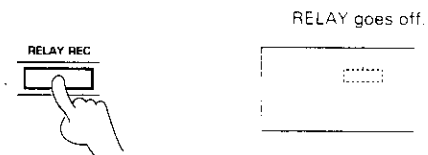

Relay recording cannot be performed if the REV.MODE key is set to "C".

Synchro recording

By connecting this unit with a KENWOOD "[XS], [XS8], [SL16]([XS8])" type receiver (amplifier) with a SYSTEM CONTROL jack and a KENWOOD CD player with a SYSTEM CONTROL jack using system control cords, recording on this unit and playback on the CD player can be started simultaneously.

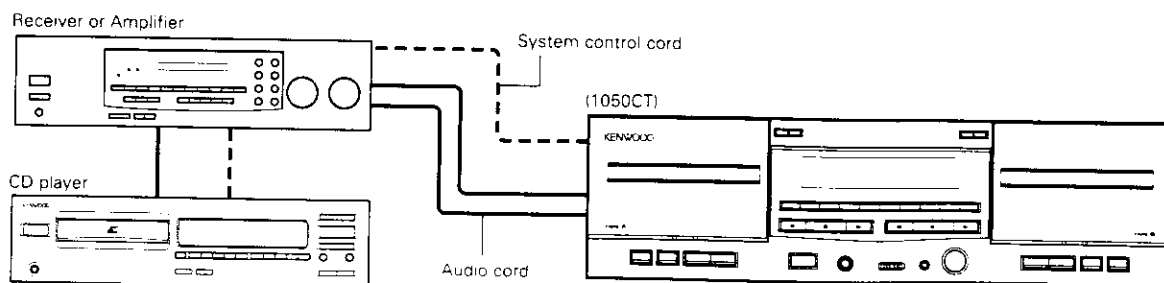

■ Synchro recording of CD

1 Make preparations for recording.

- 1 Insert a tape in deck A or B.
(103CT:deck B only)

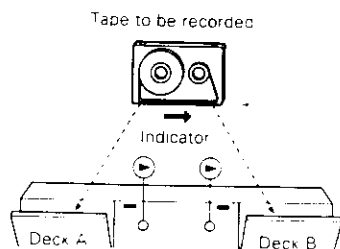

- 2 Adjust the tape transport direction.

Press the play key, then immediately press the ■ key.

- 3 Select one-side or two-side recording.

The display changes every time you press



- 4 Select the Dolby NR mode.

The display changes every time you press

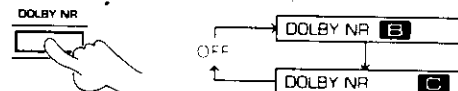

2 Activate the auto-bias setting.

The bias adjustment is applied to deck B.



- The optimum bias is set in about 40 seconds, after which the deck enters the stop mode.
- For a fine adjustment after setting AUTO BIAS, refer to the description of "Bias level adjustment" (1050CT only)
- To cancel the auto-bias adjustment operation in the middle, press the ■ key
- Recording is possible even when the auto-bias setting is omitted.

3 Adjust the recording level.

- 1 Play a CD.

- 2 Set the record-pause mode.

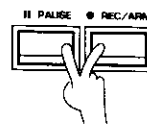

While pressing the II key, press the ● key.

- 3 Adjust the recording balance and recording level.

→ 16

- 4 Stop playing the CD.

4 Set the record-pause mode.

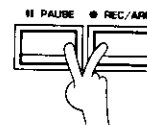

While pressing the II key, press the ● key.

5 Start playing the CD.

Press the ►/II key or the numeric key corresponding to the track No. to start recording.

- Recording starts at this moment.
- When the CD player has completed playback, the cassette deck stops recording and enters the stop mode.

To pause Press the ►/II key of the CD player.

To restart recording Press the ►/II key of the CD player.

To stop Press the ■ key of the CD player.

- If the stop key of the cassette deck is pressed, the cassette deck enters the stop mode but the CD player does not stop.

By connecting this unit with a KENWOOD "[XS]", "[XS8]", "[SL16]([XS8])" type receiver (amplifier) with a SYSTEM CONTROL jack and a KENWOOD turntable with a SYSTEM CONTROL jack using system control cords, recording on this unit and playback on the turntable can be started simultaneously.

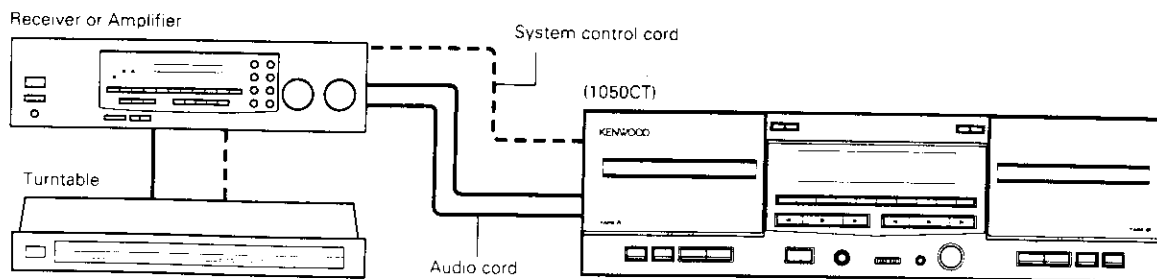

■ Synchro recording of analog disc

1 Make preparations for recording.

1. Insert a tape in deck A or B.

(103CT:deck B only)

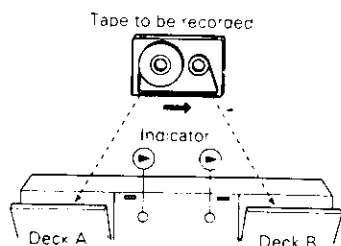

2 Adjust the tape transport direction.

Press the play key, then immediately press the **■** key.

3 Select one-side or two-side recording.

The display changes every time you press

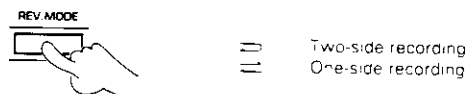

4 Select the Dolby NR mode.

The display changes every time you press

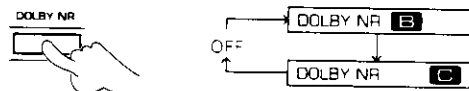

2 Activate the auto-bias setting.

The bias adjustment is applied to deck B.

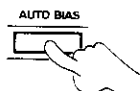

- The optimum bias is set in about 40 seconds, after which the deck enters the stop mode.
- For a fine adjustment after setting AUTO BIAS, refer to the description of "Bias level adjustment" (1050CT only)
- To cancel the auto-bias adjustment operation in the middle, press the **■** key.
- Recording is possible even when the auto-bias setting is omitted.

3 Adjust the recording level.

① Start playing an analog disc.

② Set the record-pause mode.

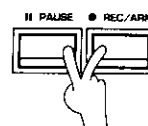

While pressing the **||** key, press the **●** key.

③ Adjust the recording balance and recording level.

④ Stop playing the analog disc.

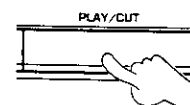

- The cassette deck returns to the stop mode.

4 Set the record-pause mode.

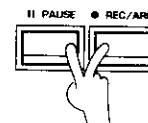

While pressing the **||** key, press the **●** key.

5 Start playing the analog disc.

Press the PLAY/CUT key of the turntable.

- Recording starts at this moment.
- When the turntable has completed the play, the cassette deck stops recording and enters the stop mode.

To stop recording in the middle

Press the PLAY/CUT key of the turntable.

- If the stop key of the cassette deck is pressed, the cassette deck enters the stop mode but the turntable does not stop.

Recording of CD playback (CCRS) (deck B only)

When connected with a KENWOOD CD player provided with "[XS]", "[XS8]", "[SL16]([XS8])" marking through the system control cord, this unit allows to use the CCRS, which starts recording automatically after setting the optimum recording level for the CD and tape to be used in recording.

CCRS (Computer-controlled CD Recording System)

When the CCRS key is pressed, the following operations occur automatically and CD sound is recorded on tape.

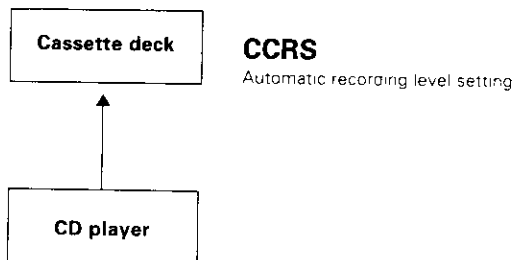

1. The CD starts to be played, and the peak value is sampled from the levels of the signals on the CD.
2. The optimum recording level for the specific CD is determined and set based on the peak value sampled.
3. The recording preparation steps above take about 20~200 seconds, after which the actual recording starts.
4. After recording (when the CD player is stopped or when the tape has run out), both the cassette deck and CD player stop.

- With CD players equipped with the EDIT function, it is possible to make recordings in which the last songs on sides A and B are not cut off in the middle and in which the recording capacity of the tape is used to the fullest extent. (Set the **REV.MODE** key of the deck to "→".)

■ CCRS recording (deck B only)

1 Set the input selector switches of the amplifier (receiver) for the CD source.

2 Place a CD in the CD player.

- When a recording is to be edited, use the CD player's EDIT function and complete the editing.

3 Insert a tape in deck B.

4 Set the playback condition.

1 Select one-side or two-side recording.

The display changes every time you press

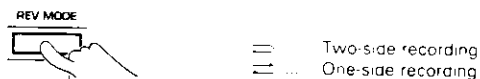

2 Select the Dolby NR mode.

The display changes every time you press

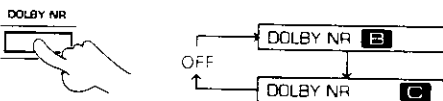

5 Press the CCRS key.

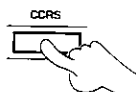

- When performing CCRS recording with a CD player which can be loaded multiple compact discs, set the CD player to TRACK mode, press the disc select key and press the **CCRS** key.
- The CCRS indicator blinks, and actual recording starts in about 20 to 200 seconds (after creating a non-recorded blank of about 8 seconds).

How to cancel CCRS

During recording level setting:

Press the **Stop** key of the CD player or the **stop** key of the cassette deck.

During CCRS recording:

Press the **Stop** key of the CD player, then press the **OPEN / CLOSE** key of the CD player.

After completion of CCRS recording:

Press the **OPEN / CLOSE** key of the CD player.

- After recording, the cassette deck and CD player enter the stop mode automatically.
- After completion of CCRS recording, be sure to cancel the CCRS and ensure that the CCRS indicator has gone off.



1. If the **CCRS** key is pressed during CD playback, playback stops and CCRS operation begins.
2. If the remaining amount of tape is small, CCRS may not function correctly or CCRS operation may be canceled in mid-operation.
3. Once the CCRS recording level has been set, the recording balance and recording level cannot be adjusted while the CCRS operation is being carried out.
4. The CCRS function sets the peak level for the entire CD in approx. 20~200 seconds. On very rare occasions, however, the function may not be able to set the optimum recording level. If this occurs, carry out recording manually referring to the "**Ordinary recording**" section.
5. The CCRS recording level setting is canceled when the **OPEN / CLOSE** key of the CD player is pressed or when the power is switched OFF.

Tape dubbing operation (Deck A → Deck B)

The dubbing refers to the copy of the recorded contents of a tape to another tape (tape in Deck A → tape in Deck B).
Normal-speed dubbing: Copy at normal tape speed.
High-speed dubbing: Copy at double the normal speed.

1 Insert tapes in the cassette decks.

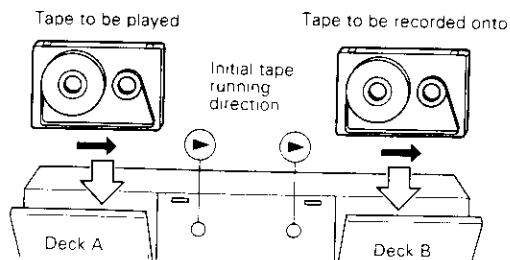

2 Set the same tape transport direction for both tapes.

Press the same play key, then immediately press the ■ key

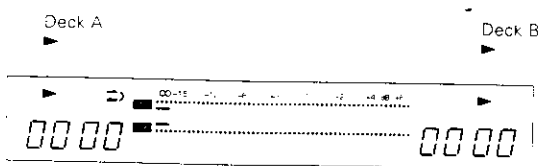

3 Select one-side or two-side dubbing mode.

The display changes every time you press



4 Press the AUTO BIAS key.

- The optimum bias is set in about 40 seconds, after which the cassette decks enter the stop mode.
- Recording is possible even when the auto-bias setting is omitted.

5 Start dubbing.

For normal-speed dubbing

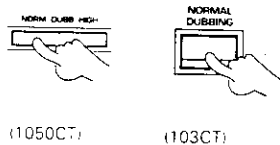

For high-speed dubbing

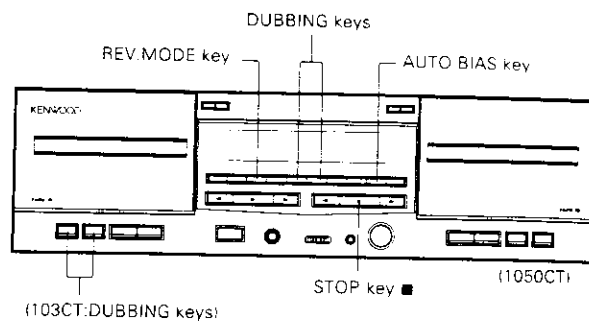
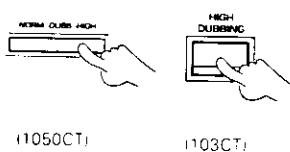

To pause dubbing

For normal-speed dubbing

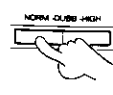

(1050CT)



(103CT)

For high-speed dubbing

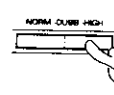

(1050CT)



(103CT)

- Only deck B enters the record-pause mode after leaving a non-recorded space of about 4 seconds in case of normal-speed dubbing, or about 6 seconds in case of high-speed dubbing.
- To resume dubbing after pause, press the same **DUBBING** key as above (**NORMAL DUBBING** or **HIGH DUBBING**) again.

To stop dubbing

Press the ■ key of Deck B.

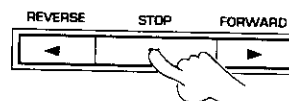

- Both decks A and B enter the stop mode.



- The recording balance and recording level cannot be adjusted for dubbing.
- The DOLBY NR is not active during dubbing.
 - * The tape recorded by dubbing features the same NR system as the original tape in Deck A.
- Noise from TV may interfere with dubbed sound if high-speed dubbing is executed near a TV set. To prevent this, install the system farther from the TV set.
- If the original tape was recorded at a high level, the sound quality may be degraded, if high-speed dubbing is used. In such a case, use normal-speed dubbing.

Timer operations

This unit incorporates a built-in timer standby function. By using an audio timer optionally available in the market, wake-up playback and unattended recording of tape can be started at any time of the day.

Preparations for timer playback and recording
Connect the power cords of the components directly or indirectly to the timer so that their powers can be turned on via the timer.

The timer setup operation varies depending on the timer. Also read carefully the instruction manual of your audio timer.

When connecting the KENWOOD equipment (Receiver or Amplifier, CD player) and the system, remove the disc from the CD player.

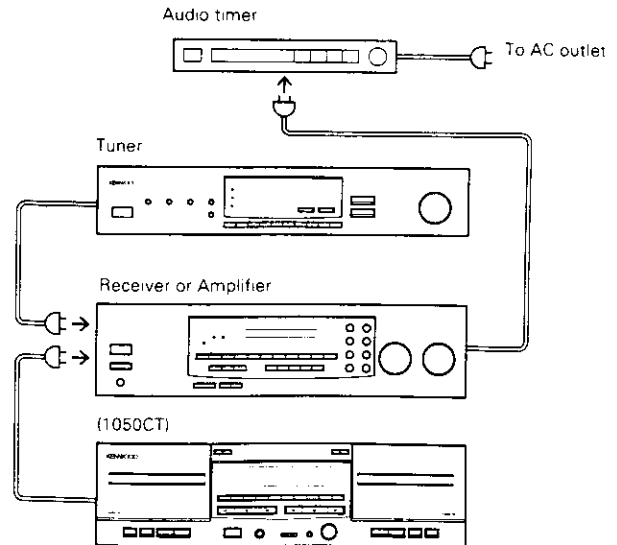

■ Timer playback of tape

1 Set the power switches of the components to ON.

2 Insert a cassette tape(s).

- The type of tape, Normal(TYPE I), High(TYPE II) or Metal(TYPE IV), is detected and set automatically.
- Remove the tape slack before insertion.
- If relay playback is required, insert tapes in both decks A and B.

3 Set the playback condition.

1 Select the playback mode.

The display changes every time you press

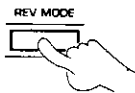

- "≡" ... Stops after playing two sides
- "∞" ... Endless playback
- "≡" ... Stops after playing one side

- If relay playback is required, set to "≡" or "≡".

2 Select the Dolby NR mode.

The display changes every time you press

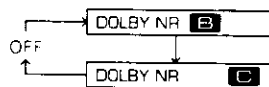
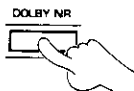

- Set according to the tape(s) to be played.

4 Start playback.

5 Adjust the volume of the amplifier.

6 Rewind the tape(s) to the start position.

7 Set the TIMER switch to PLAY.



8 Set the timer.

- Set the timer so that the tape starts at the desired time of the day.
- When the set time comes, tape playback starts automatically.
- Read carefully the instruction manual of your audio timer.



1. If tapes are inserted in both decks A and B, timer playback starts with deck B.
2. Switch on the power to the cassette deck. (The timer will not operate if it is switched off.)

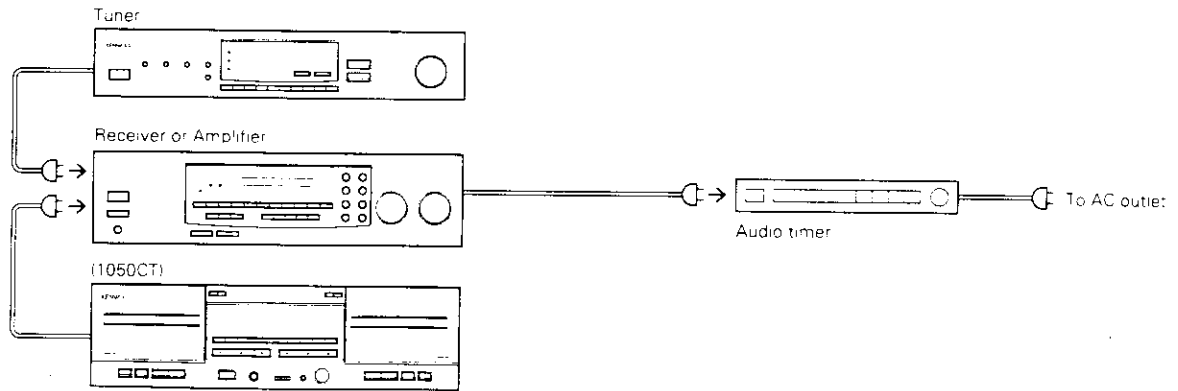

■ Timer recording of tuner broadcast

1 Set the power switches of the components to ON.

2 Receive the desired radio station with the tuner.

3 Make preparations of the cassette deck.

1 Insert a tape(s) in a cassette deck.

- Insert a tape into either deck A or deck B (103CT: deck B only).
- For relay recording, insert tapes into both decks A and B. (1050CT only).

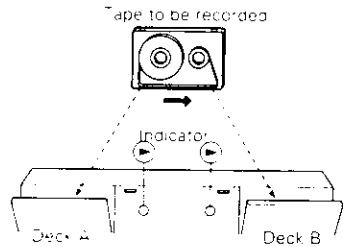

2 Adjust the tape transport direction.

Press the play key, then immediately press the key.

3 Select one-side or two-side recording.

The display changes every time you press



4 Select the Dolby NR mode.

The display changes every time you press

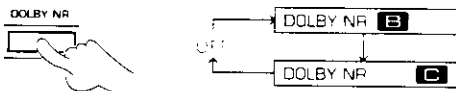

5 Set the MPX FILTER to ON.

- 14 -

4 Adjust the recording level.

1 Set the record-pause mode.

- While pressing the key, press the key.

2 Adjust the recording level.

- Adjust the recording level so that the 0 dB of the peak level indicators sometimes light up.

5 Set the relay recording as required. (1050CT only)

Set the relay recording mode.



- Relay recording is not set, deck B will record.

6 Set the amplifier volume to the minimum position.

7 Set the TIMER switch to REC.



8 Set the timer.

- Set the desired time when the recording is to be started.
- When the set time comes, the powers of the related components are turned ON and recording starts.
- Recording stops when the end of side to be recorded is reached.
- Read carefully the instruction manual of your audio timer.



- 1 To ensure that the cassette deck's automatic shut off switch operates before the power is shut off, set the timer so that it operates for a little longer than the playing time of the tape.
- 2 Switch on the power to the cassette deck. (The timer will not operate if it is switched off.)

In case of difficulty

What appears to be a malfunction may not always be serious. If your unit should not perform as expected, consult the table below to see if the problem can be corrected before seeking help from your dealer or service representative.

Operation to reset

The microcomputer may fall into malfunction (impossibility to operate, erroneous display, etc.) when the power cord is unplugged while power is ON or due to an external factor. In this case, execute the following method to reset the microcomputer and return it to normal condition.



Turn the power switch on and off again while pressing the Stop key on deck B.

- Please note that resetting microcomputer clears contents stored in and returns it to the condition when it left the factory.

Symptom	Cause	Remedy
Sounds is not produced when the Play key is pressed.	<ul style="list-style-type: none"> • The connection cords are connected improperly. • The head is dirty. • Tape is irregularly wound and hard to take up. • A non-recorded tape is being played. 	<ul style="list-style-type: none"> • Connect the cords properly referring to "System connections". • Clean the head referring to "Cleaning the head section". - 5 • Replace the tape. • Play a recorded tape.
The deck does not work when an operation key is pressed.	<ul style="list-style-type: none"> • The cassette holder is not closed completely. • The operation key was pressed immediately after closing the cassette holder. • The operation key was pressed within less than 3 seconds after the power was turned on. • Tape is not inserted. • Tape is irregularly wound and hard to take up. • Tape has been fully wound to reel. 	<ul style="list-style-type: none"> • Close the cassette holder completely. • Press the desired operation key in a few seconds after closing the cassette holder. • Press the desired operation key in more than 3 seconds after turning the power on. • Insert a tape. • Replace the tape. • Change the tape transport direction or insert the tape inversely.
DPSS malfunctions.	<ul style="list-style-type: none"> • The tape is not suitable for DPSS operation, for example the spaces between tunes are too short. 	<ul style="list-style-type: none"> • Read "DPSS operation". - 11
CCRS does not work.	<ul style="list-style-type: none"> • A recordable tape is not inserted in deck B. • A disc is not placed in the CD player. • The disc is dirty. 	<ul style="list-style-type: none"> • Insert a recordable tape in deck B and press the CCRS key. • Place a disc in the CD player and press the CCRS key. • Clean the disc, place it in the CD player, and press the CCRS key.
The dubbing on Deck A and Deck B ends at different timing.	<ul style="list-style-type: none"> • This is due to the difference in tape length or to the characteristics of the cassette deck mechanisms. 	<ul style="list-style-type: none"> • A small time difference is not regarded as a failure.
The cassette holder does not open when the Eject button is pressed.	<ul style="list-style-type: none"> • The button is pressed during recording or playback. 	<ul style="list-style-type: none"> • Press in the stop mode.
Sound is hoarse, or high frequencies are not audible.	<ul style="list-style-type: none"> • The head is dirty. • The tape is stretched or wrinkled. 	<ul style="list-style-type: none"> • Clean the head referring to "Cleaning the head section". - 5 • Replace the tape.
Sound is distorted.	<ul style="list-style-type: none"> • The recording level was too high. • A tape recorded with distorted sound is being played. 	<ul style="list-style-type: none"> • Adjust the recording level referring to "How to record". - 14 • Replace the tape.

Symptom	Cause	Remedy
Recording is not initiated when the ●REC/ARM key is pressed.	<ul style="list-style-type: none"> The protection tab on the cassette has been broken. The cassette holder is not closed completely The recording level is set to the minimum position. The TAPE input selector is selected on the amplifier. Tape has been fully wound to a reel. 	<ul style="list-style-type: none"> Use a cassette with unbroken tab or close the hole. Close the cassette holder completely. Adjust the recording level referring to "How to record". - 14 Press the input selector key of the source to be recorded. Change the tape transport direction of deck or insert the tape inversely.
Noise level is high.	<ul style="list-style-type: none"> The head is magnetized. External noise is induced. The system assembly position is wrong. The recording level was too low. A tape recorded with Dolby NR ON is being played with Dolby NR OFF. 	<ul style="list-style-type: none"> Demagnetize the head referring to "Cleaning the head section". - 5 Install the system apart from other electrical appliances and TV set. Change the arrangement or the position of the equipment. Adjust the recording level referring to "How to record". - 14 Set the DOLBY NR key to B or C
Sound is vibrating.	<ul style="list-style-type: none"> The capstans or pinch rollers are dirty. Tape is irregularly wound. 	<ul style="list-style-type: none"> Clean the head referring to "Cleaning the head section". - 5 Wind the tape regularly by fast forwarding, rewinding or playing it fully from one reel to another.
Playback or recording starts immediately when the power is switched ON.	<ul style="list-style-type: none"> The TIMER switch is set to PLAY or REC 	<ul style="list-style-type: none"> Set the TIMER switch to OFF unless timer playback or timer recording is required.



1. With some tapes, a squeaky noise is produced when the tape is stopped automatically. This is due to the tape protection function, and not a malfunction.
2. Do not use longer tape than 110 minutes tapes, for the tape is too thin and gets easily tangled.

Specifications

[MODEL: 1050CT]

Track System	4 track, 2 channel stereo
Recording System	AC bias (Frequency: 105 kHz)
Heads	A DECK Playback/recording heads 1 Erasing head
	1 B DECK Playback/recording heads 1 Erasing head
	1 Motors
	A DECK DC motor × 1 B DECK DC motor × 1
Wow and Flutter	±0.17 % (IEC) ±0.28 % (DIN) 0.1 % (W.R.M.S)
Fast Winding Time	Approx. 110 seconds (C-60 tape)
Frequency Response	
TYPE I tape	30 Hz to 18,000 Hz, ±3 dB
TYPE II tape	30 Hz to 19,000 Hz, ±3 dB
Signal to Noise Ratio	
Dolby NR OFF	56 dB (IEC, 250 nWb/m, TYPE II tape)
Dolby NR OFF	59 dB
Dolby B NR ON	68 dB
Dolby C NR ON	75 dB (3rd, H.D., 3 %, TYPE II tape)
Harmonic Distortion	Less than 1.2 % (at 315 Hz, 3rd H.D., 250 nWb/m, TYPE II tape)
Input sensitivity/Impedance	
LINE IN	122.8 mV/47 kΩ
Output Level/Impedance	
LINE OUT	775 mV/1.0 kΩ
Headphones	0.5 mW/32 Ω
[General]	
Power Consumption	30 W
Dimensions	W: 440 mm (17-5/16") H: 134 mm (5-1/4") D: 367 mm (14-7/16")
Weight (Net)	4.6 kg (10.1 lb)

[MODEL: 103CT]

Track System	4 track, 2 channel stereo
Recording System	AC bias (Frequency: 105 kHz)
Heads	A DECK Playback head
	1 B DECK Playback/recording heads 1 Erasing head
	1 Motors
	A DECK DC motor × 1 B DECK DC motor × 1
Wow and Flutter	±0.17 % (IEC) ±0.28 % (DIN) 0.1 % (W.R.M.S)
Fast Winding Time	Approx. 110 seconds (C-60 tape)
Frequency Response	
TYPE I tape	30 Hz to 18,000 Hz, ±3 dB
TYPE II tape	30 Hz to 19,000 Hz, ±3 dB
Signal to Noise Ratio	
Dolby NR OFF	56 dB (IEC, 250 nWb/m, TYPE II tape)
Dolby NR OFF	59 dB
Dolby B NR ON	68 dB
Dolby C NR ON	75 dB (3rd, H.D., 3 %, TYPE II tape)
Harmonic Distortion	Less than 1.2 % (at 315 Hz, 3rd H.D., 250 nWb/m, TYPE II tape)
Input sensitivity/Impedance	
LINE IN	122.8 mV/47 kΩ
Output Level/Impedance	
LINE OUT	775 mV/1.0 kΩ
Headphones	0.5 mW/32 Ω
[General]	
Power Consumption	30 W
Dimensions	W: 440 mm (17-5/16") H: 134 mm (5-1/4") D: 367 mm (14-7/16")
Weight (Net)	4.6 kg (10.1 lb)



KENWOOD follows a policy of continuous advancements in development. For this reason specifications may be changed without notice.

For the U.S.A. FCC WARNING:

This equipment may generate or use radio frequency energy. Changes or modifications to this equipment may cause harmful interference unless the modifications are expressly approved in the instruction manual. The user could lose the authority to operate this equipment if an unauthorized change or modification is made.

NOTE:

This equipment has been tested and found to comply with the limits for a Class B digital device, pursuant to Part 15 of the FCC Rules. These limits are designed to provide reasonable protection against harmful interference in a residential installation. This equipment may cause harmful interference to radio communications, if it is not installed and used in accordance with the instructions. However, there is no guarantee that interference will not occur in a particular installation. If this equipment does cause harmful interference to radio or television reception, which can be determined by turning the equipment off and on, the user is encouraged to try to correct the interference by one or more of the following measures:

- Reorient or relocate the receiving antenna.
- Increase the separation between the equipment and receiver.
- Connect the equipment into an outlet on a circuit different from that to which the receiver is connected.
- Consult the dealer or an experienced radio/TV technician for help.

MEMO:

